

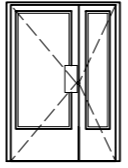

O1	O2	O3	O4
200/150 12 szt.	200/240 3 szt.	200/110 7 szt.	60/120 2 szt.

Okna pcw w kolorze białym szklone szyba zespoloną, podwójną.  
 Podokienniki zewnętrzne systemowe, aluminiowe w kolorze brązowym.  
 Podokienniki wewnętrzne konglomerat  
 W każdym skrzydle okiennym nawiewnik

					
Dz1 140/200 1L zewnątrzne	Dz2 90/200 2L zewnątrzne	D1 90/200 4P, 1L wewnętrzne	D2 90/200 4P, 2L wewnętrzne	D3 90/200 4P wewnętrzne	D4 90/200 1P wewnętrzne

Drzwi drewniane, wyposażone w sztyld z klamką. W drzwiach zewnętrznych dodatkowo 2 zamki patentowe.  
 W drzwiach łazienkowych zamek łazienkowy oraz nawiewy w dolnej części skrzydła.

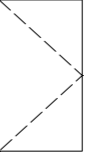
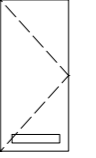
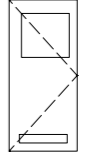
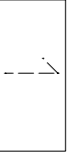
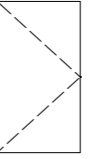
drzwi z komunikacji ogólnej

90/200 1L, 3P wewnętrzne, ppoż. EI30

wymiary otworów okiennych i drzwiowych należy sprawdzić na budowie